

# CP-CB Series

## Commercial Charbroilers CP-G24-M

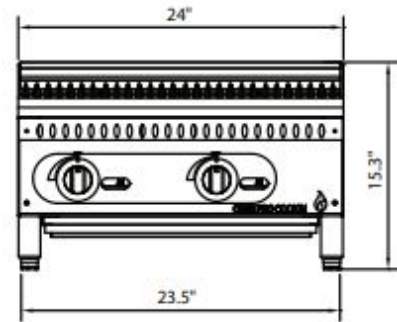
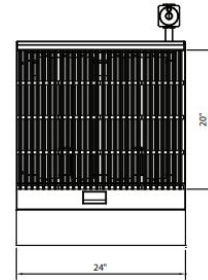
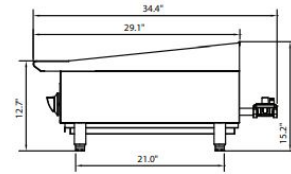

Temperature Range

BTUs

Dimensions - HxWxD mm / in

200°F - 500°F

70,000

386 / 15 ¼"

610 / 24"

710 / 29"

- "U" shape burners provide even heat distribution every 6"
- Adjustable pilot light lit from front of unit
- 35,000 BTU / burner
- 10 ga. Stainless Steel Radiants
- Gas control knob every 12"
- All stainless steel cabinet
- Double wall insulated sides
- Widths: 24", 36", 48"
- "Cool-to-the-touch" front s/s edge
- Back and side splash guards
- Flue located on back of unit for ample ventilation
- Adjustable stainless steel legs, non-skid feet
- Each Charbroiler shipped standard Natural gas, LP conversion kit included
- Easy to remove full width crumb tray
- 1 year parts & labor warranty

# CP-CB Series

## Commercial Charbroilers CP-G24-M

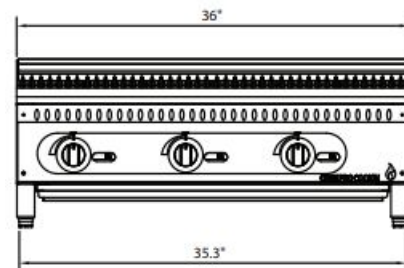
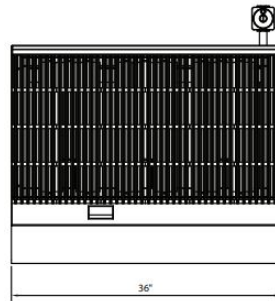
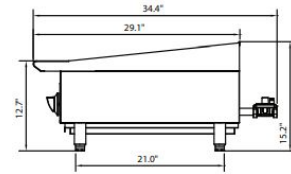

Temperature Range

BTUs

Dimensions - HxWxD mm / in

200°F - 500°F

105,000

386 / 15 1/4"

914 / 36"

710 / 29"

- "U" shape burners provide even heat distribution every 6"
- Adjustable pilot light lit from front of unit
- 35,000 BTU / burner
- 10 ga. Stainless Steel Radiants
- Gas control knob every 12"
- All stainless steel cabinet
- Double wall insulated sides
- Widths: 24", 36", 48"
- "Cool-to-the-touch" front s/s edge
- Back and side splash guards
- Flue located on back of unit for ample ventilation
- Adjustable stainless steel legs, non-skid feet
- Each Charbroiler shipped standard Natural gas, LP conversion kit included
- Easy to remove full width crumb tray
- 1 year parts & labor warranty

# CP-CB Series

## Commercial Charbroilers CP-G24-M

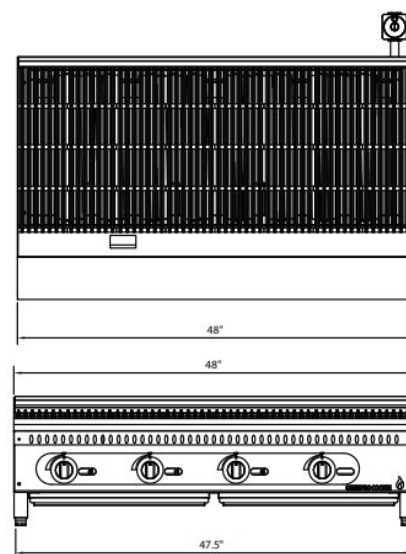
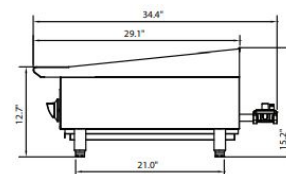

Temperature Range

BTUs

Dimensions - HxWxD mm / in

200°F - 500°F

140,000

386 / 15 1/4"

1220 / 48"

710 / 29"

- "U" shape burners provide even heat distribution every 6"
- Adjustable pilot light lit from front of unit
- 35,000 BTU / burner
- 10 ga. Stainless Steel Radiants
- Gas control knob every 12"
- All stainless steel cabinet
- Double wall insulated sides
- Widths: 24", 36", 48"
- "Cool-to-the-touch" front s/s edge
- Back and side splash guards
- Flue located on back of unit for ample ventilation
- Adjustable stainless steel legs, non-skid feet
- Each Charbroiler shipped standard Natural gas, LP conversion kit included
- Easy to remove full width crumb tray
- 1 year parts & labor warranty